

*Law via the Internet*  
*Florence , 30-31 October 2008*

# **ICT and Quality of Legal Information**

*Harald Hoffmann – Friedrich Lachmayer*

# Traditional Vertical Concept of Legal Communication

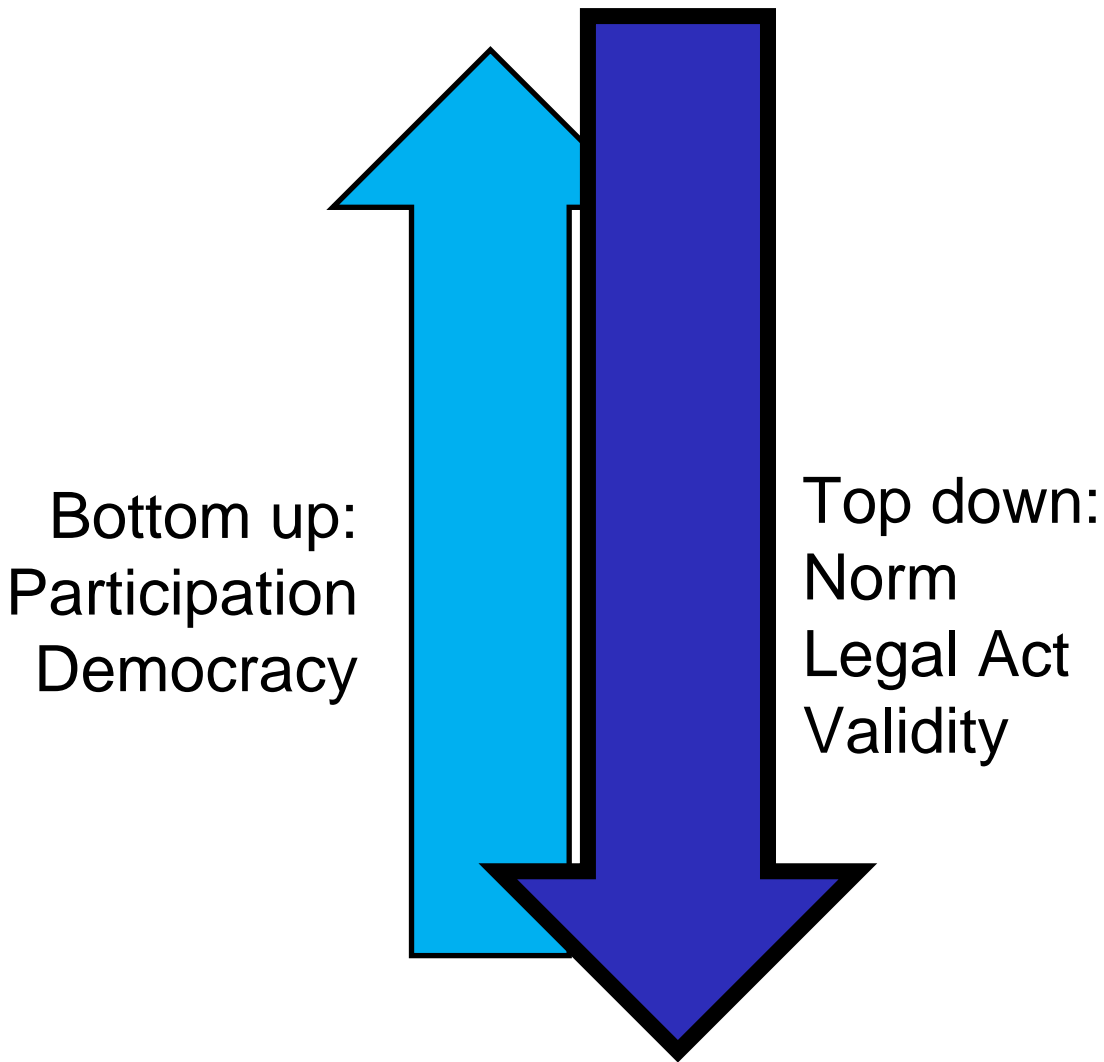

# New Horizontal Concept of Legal Workflow

Paradigmatical  
Change

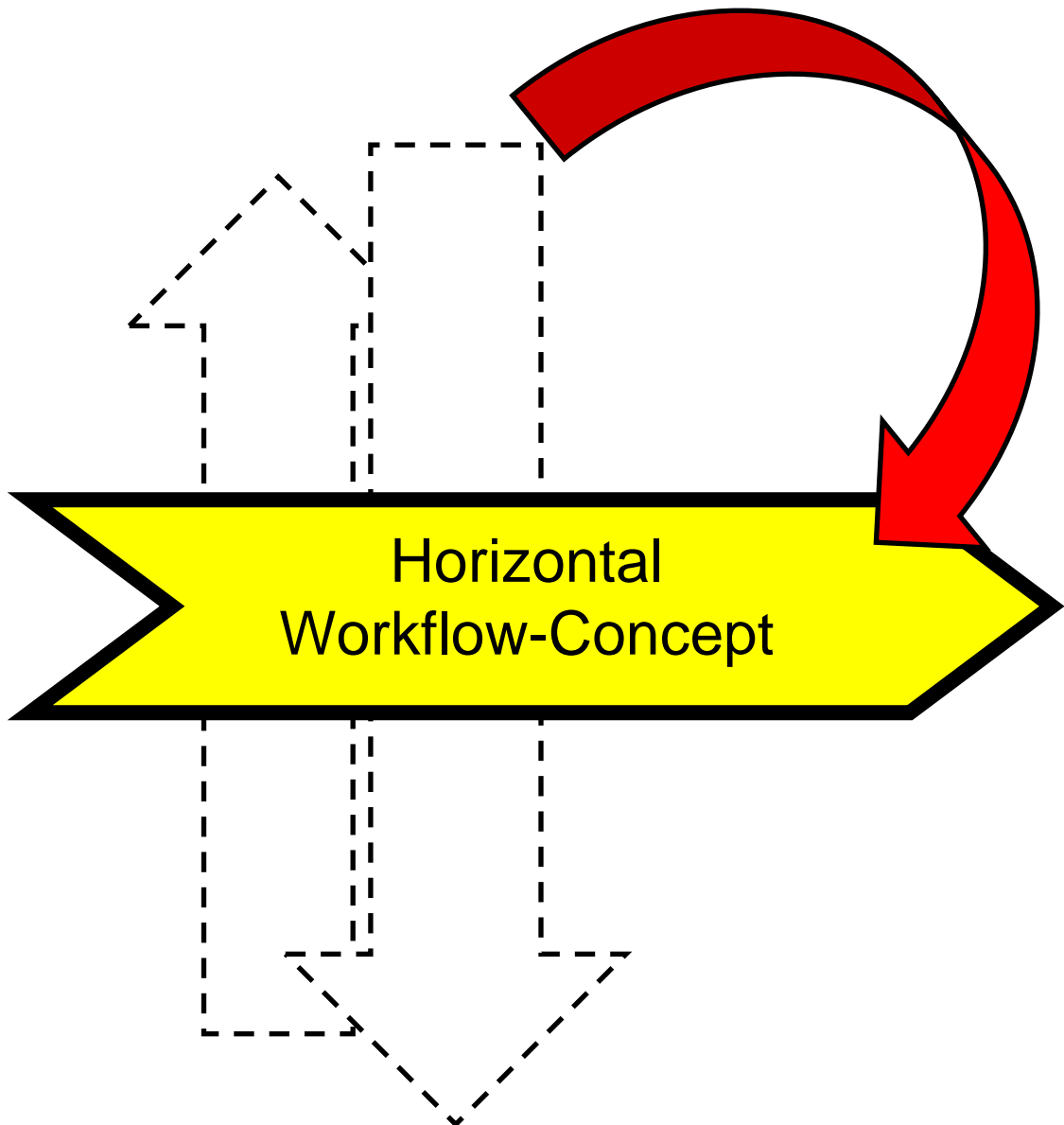

# Legal Act as an Product

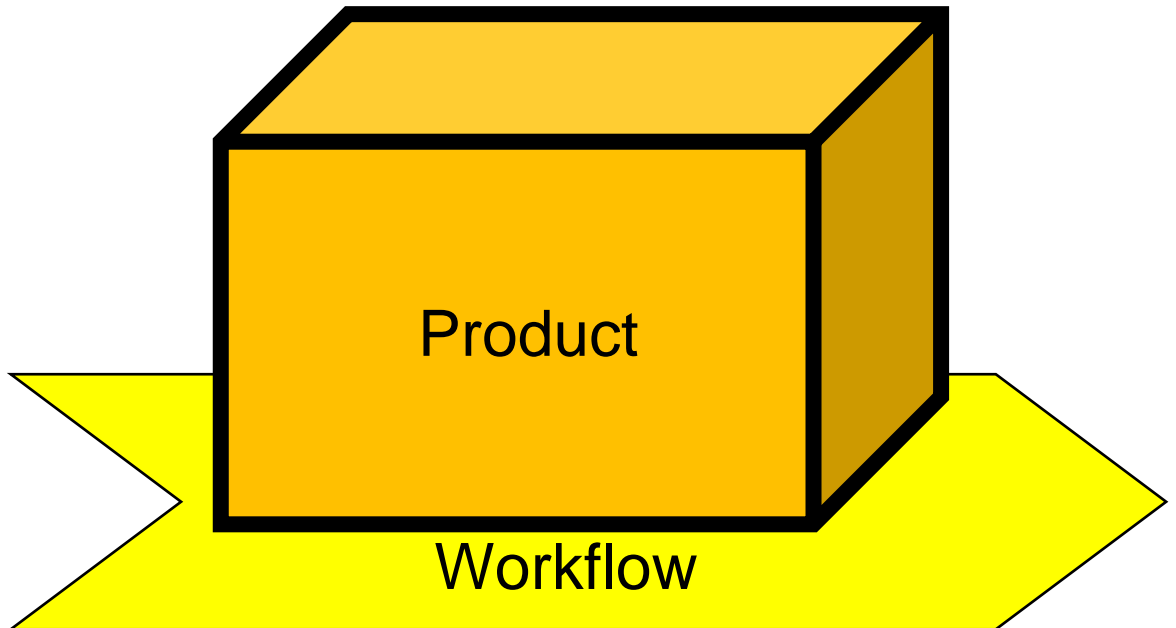

# Usage of the Legal Product

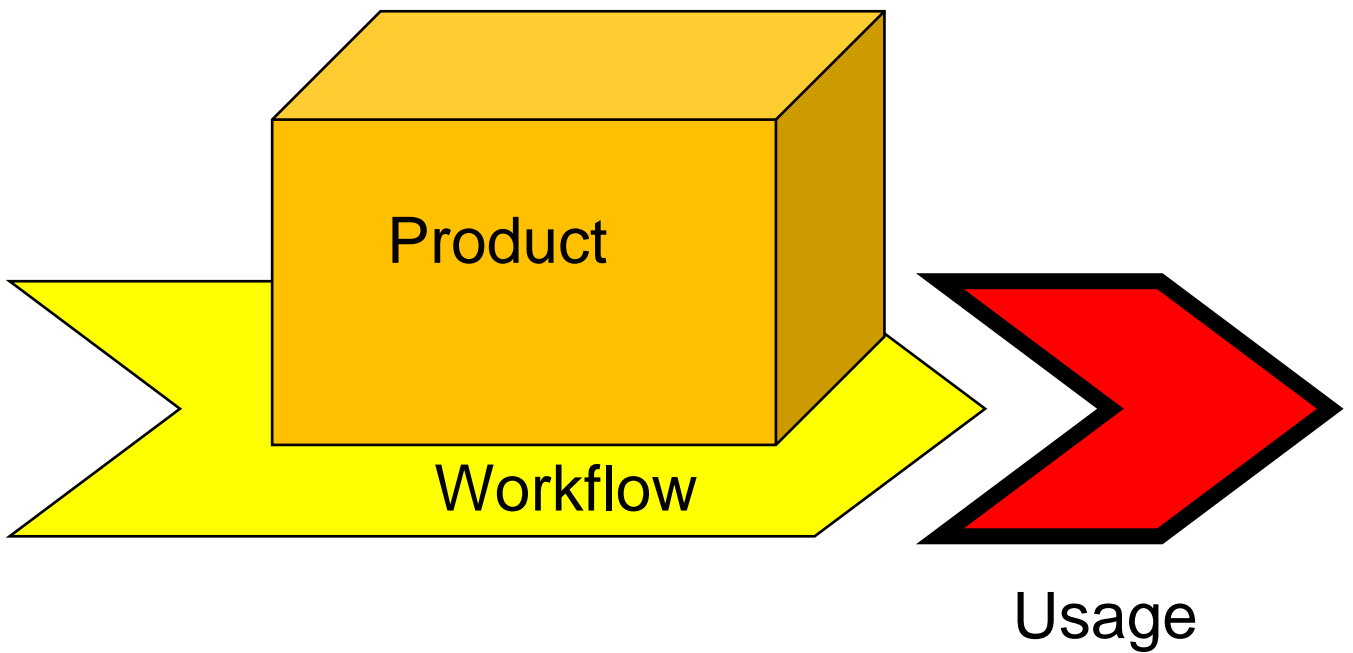

# Legal Theory as an Input for Legal Products

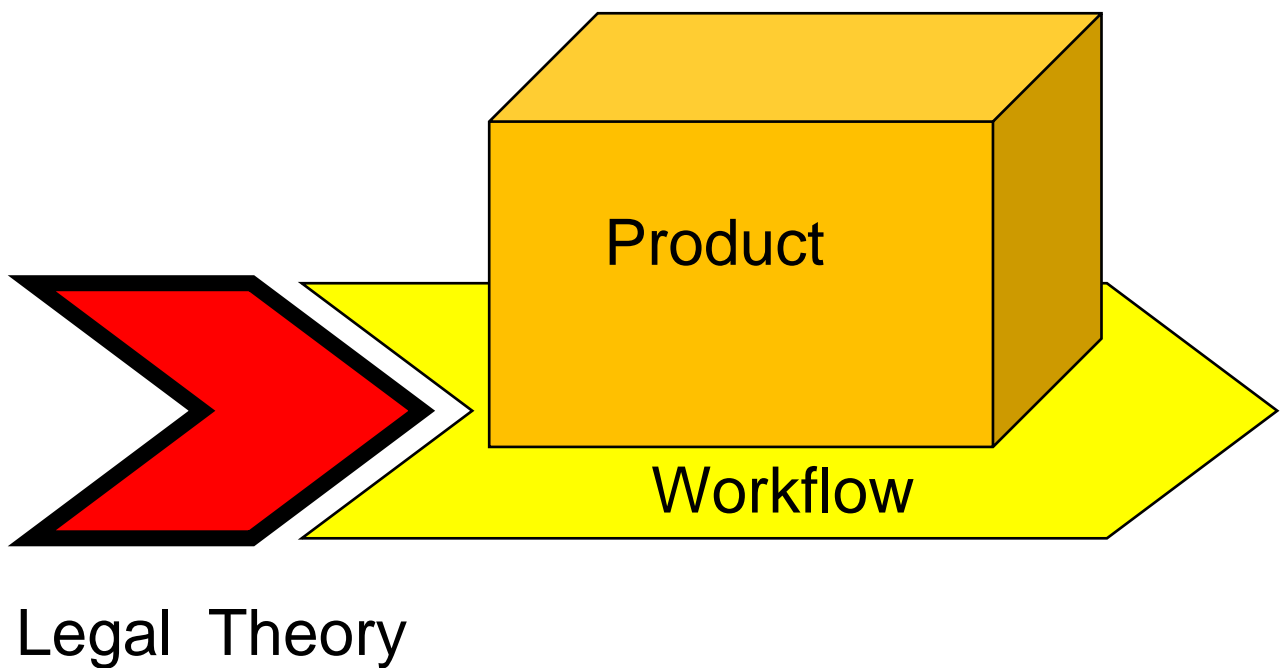

# Production: Automatical versus Semiautomatical Workflow

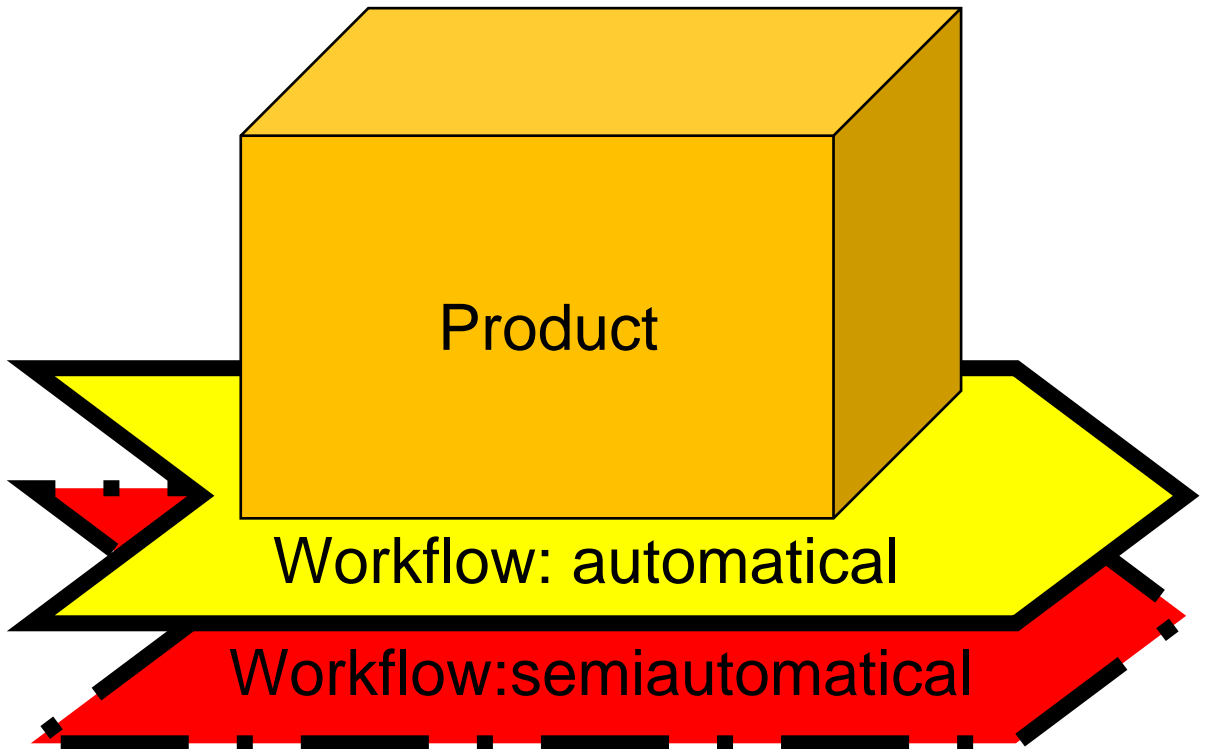

# Legal Container – Legal Content

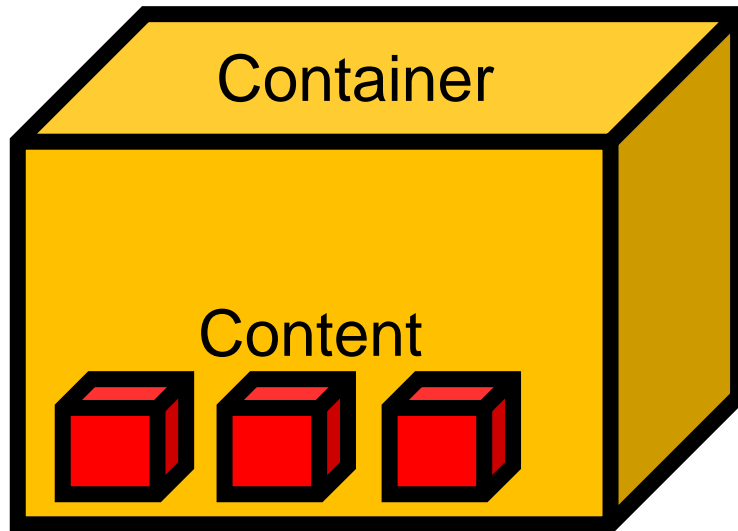

# Metadata

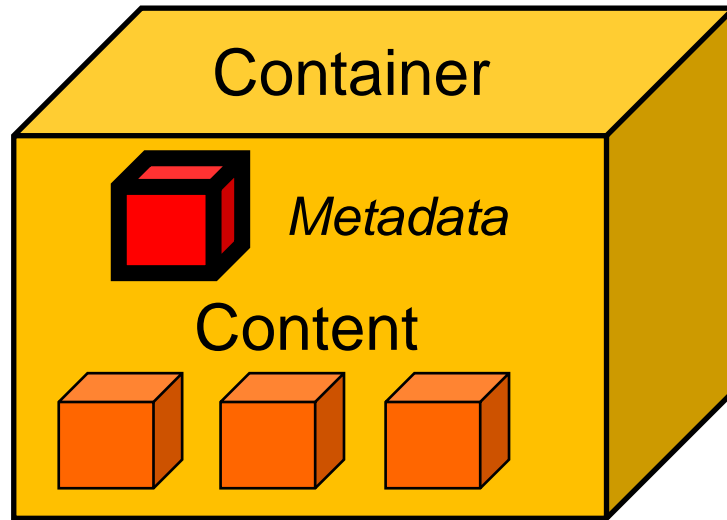

# Legislative Standards

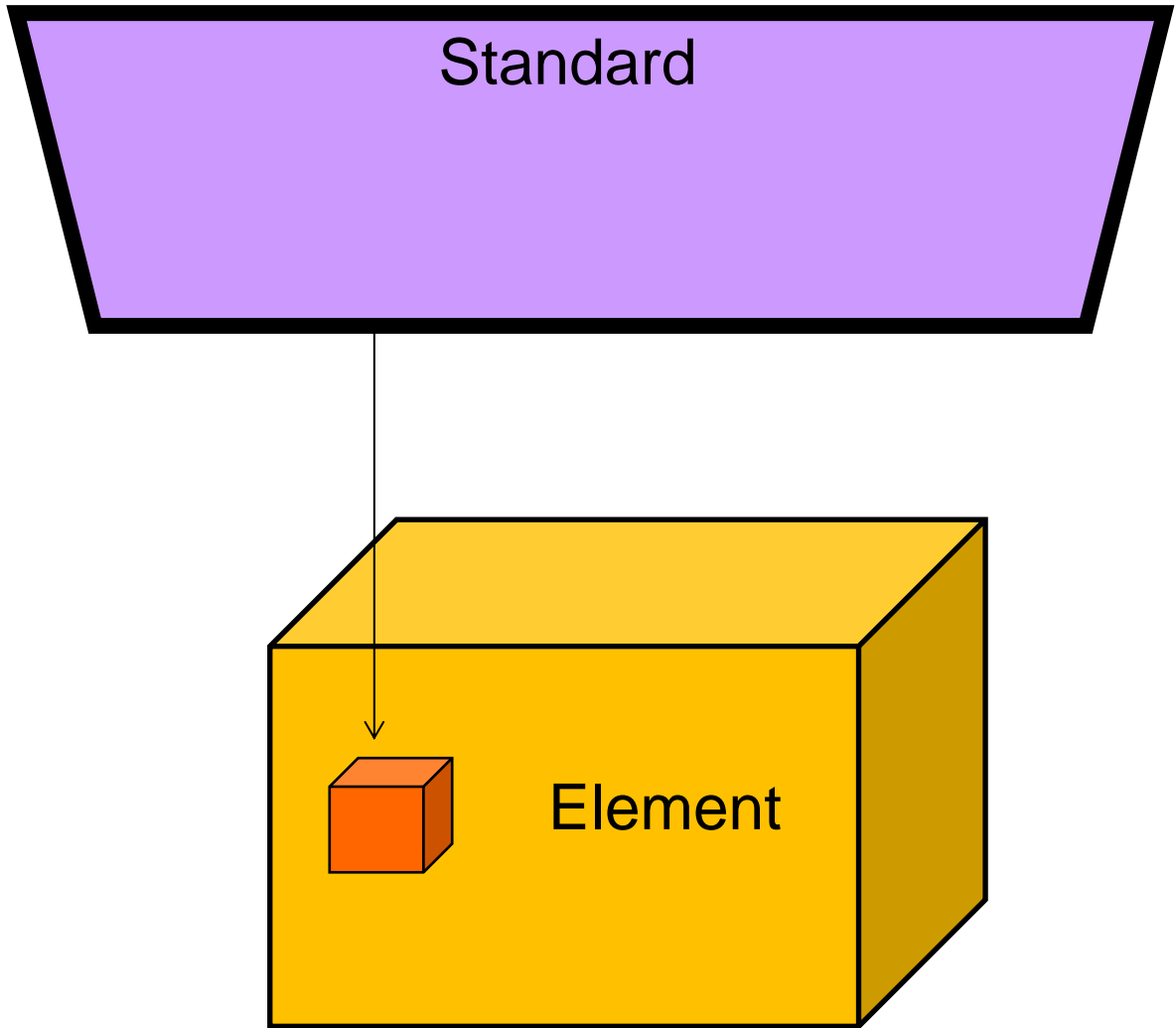

# ex ante > ex post

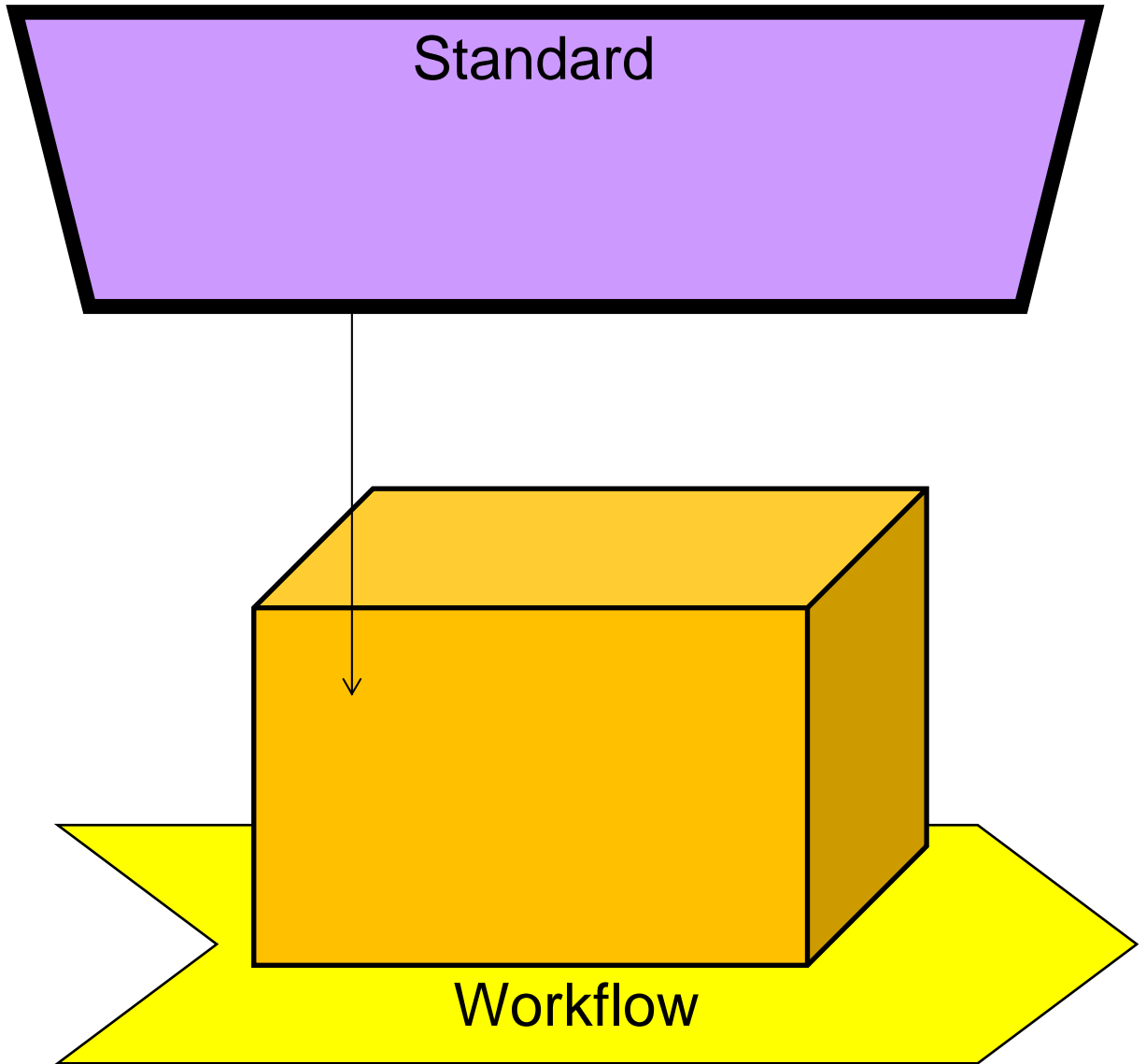

Rationality :ex ante ← ex post  
Legists ← Documentalists

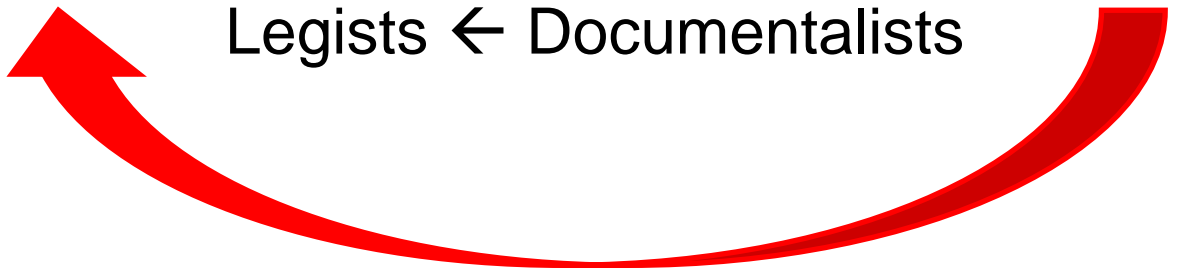

# Standard: Norm-to-Be

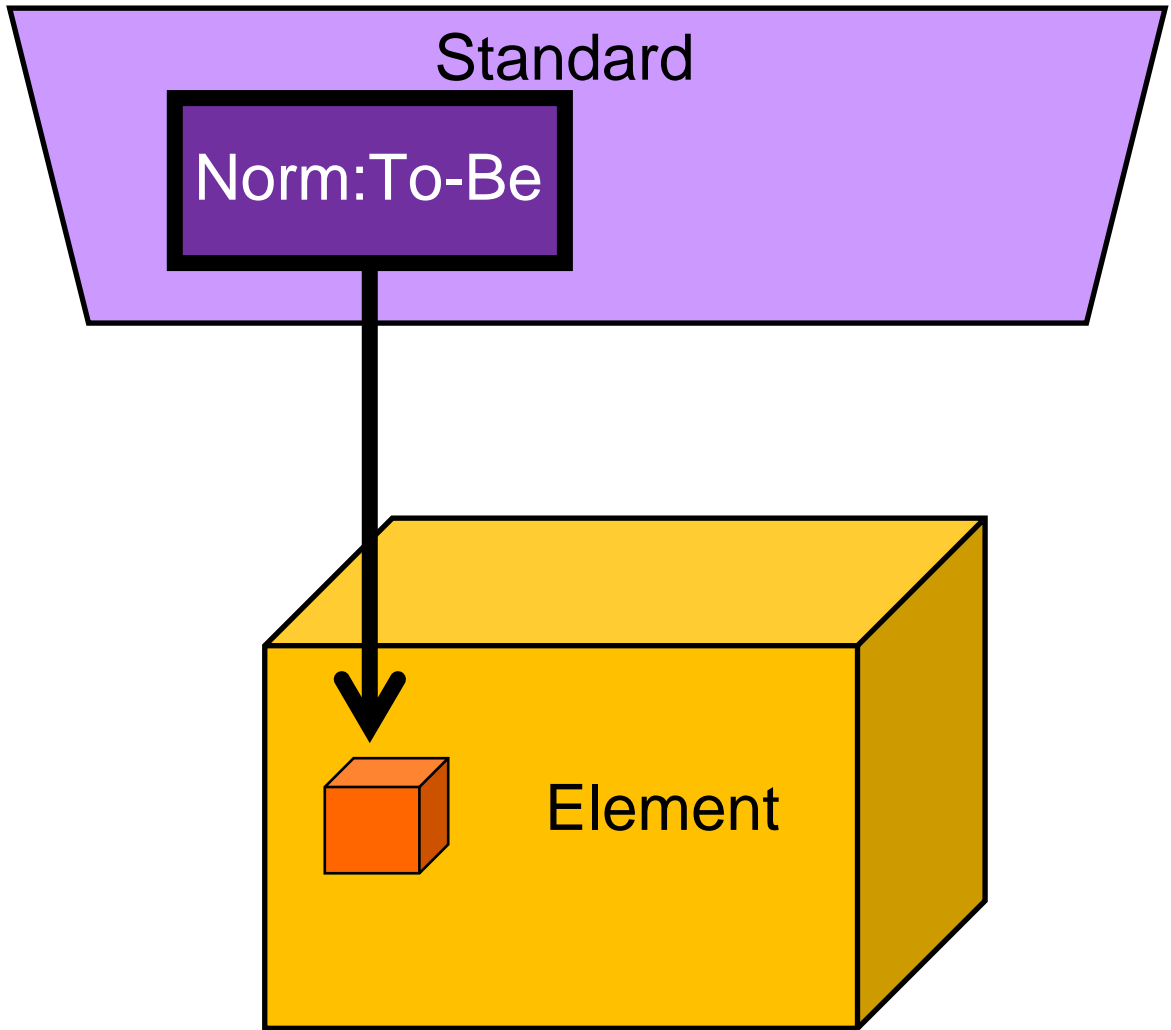

# Standards: Qualification

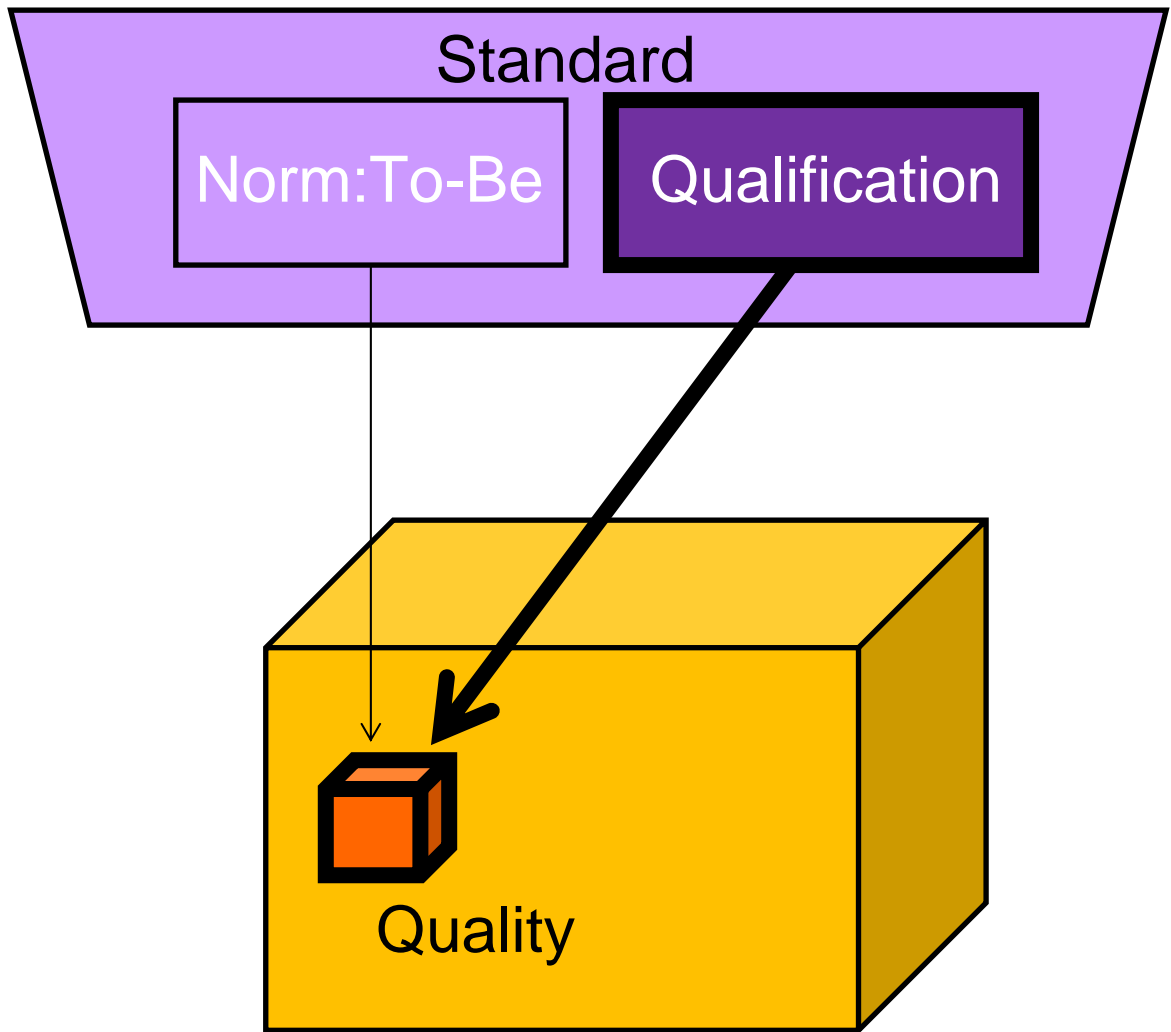

# Functions of Quality

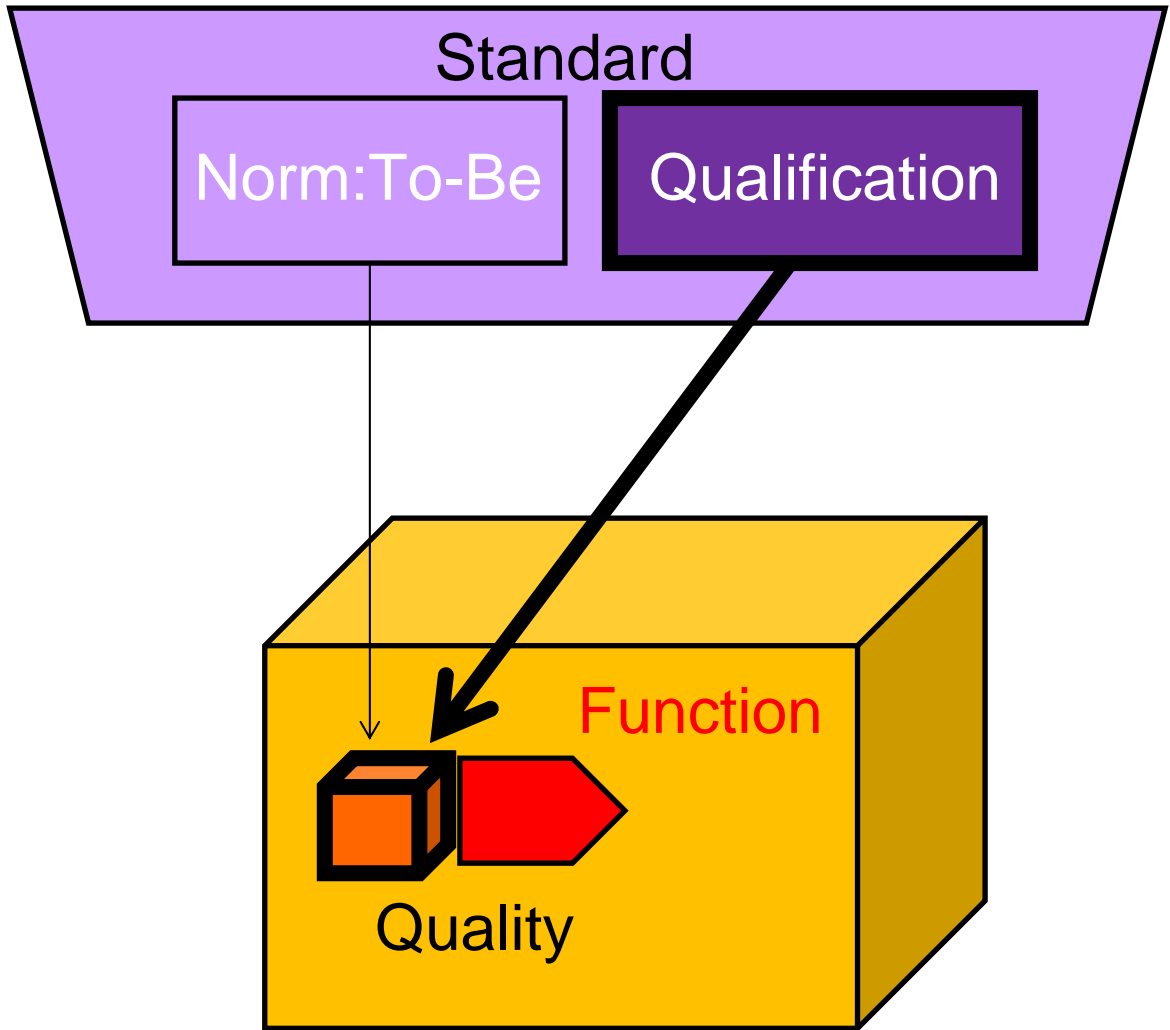

# Formal and Material Structure of Legal Acts

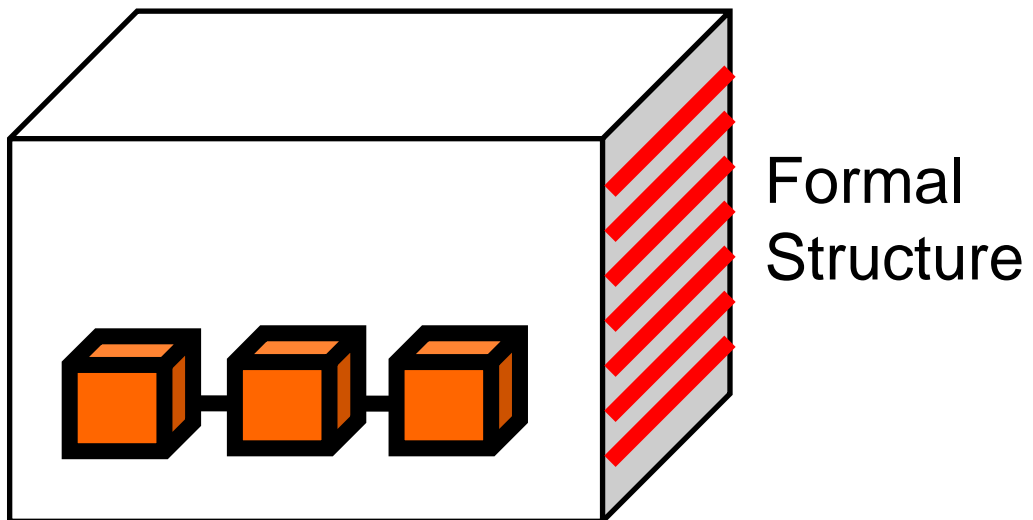

Material Structure  
Legal Provisions

# Correlation between Formal and Material Structures

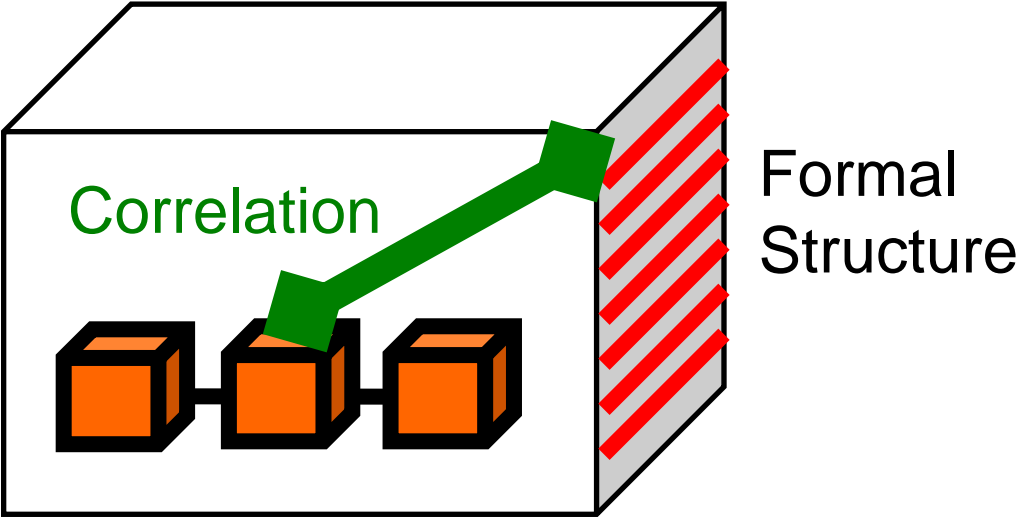

Material Structure  
Legal Provisions

# Formal Standardisation

RIS

Formal Standards

Norms: To-Be  
Qualifications

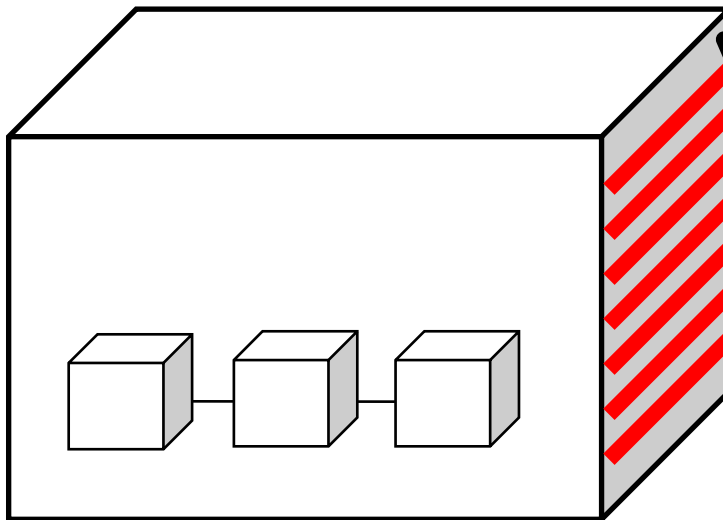

Formal  
Structure

Material Structure  
Legal Provisions

# Semantical Standardisation

**Terms, Ontologies**  
**Principles**  
**General Norms**  
**Individual Norms**

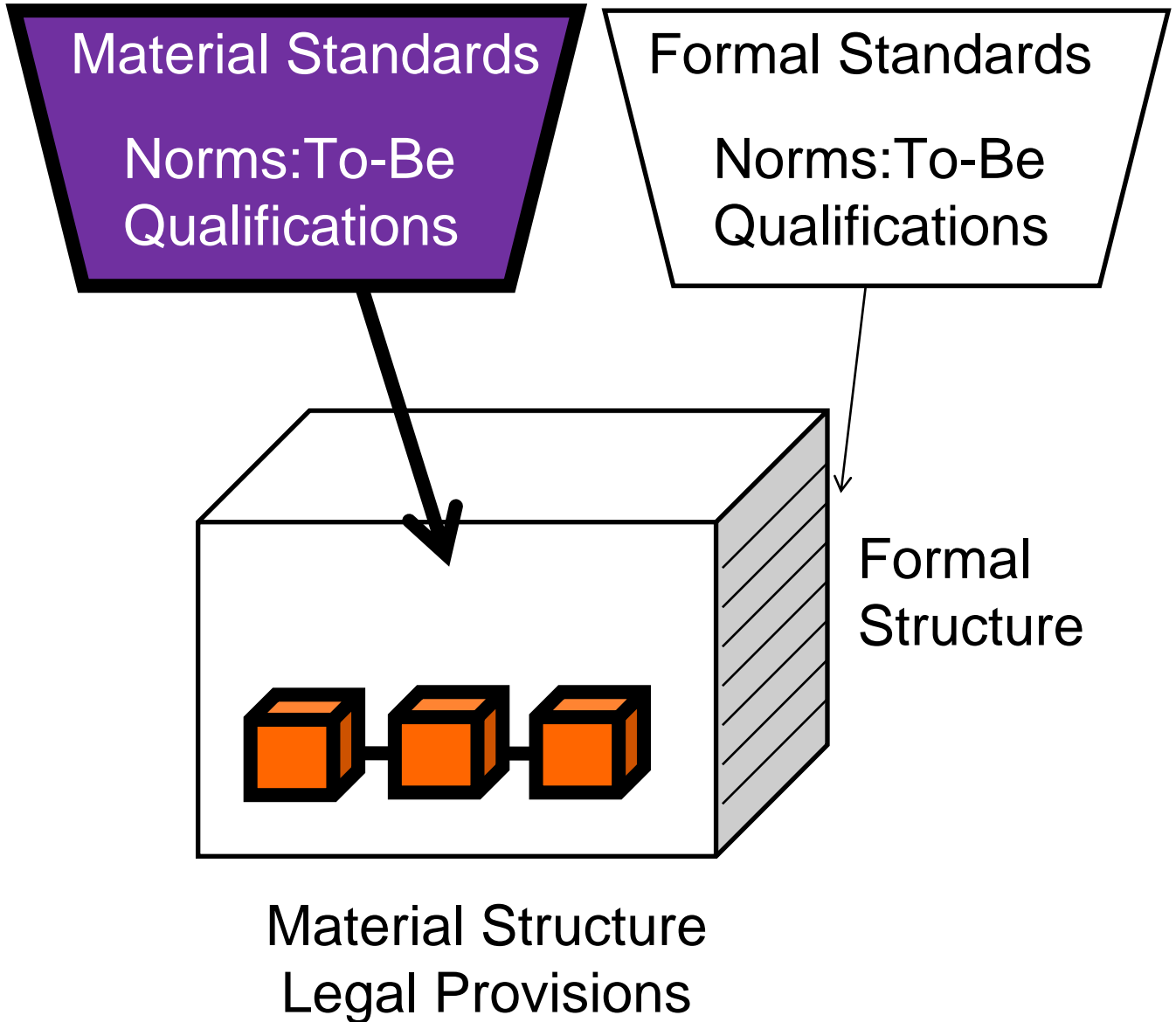

# Towards Explicite Semantics 1

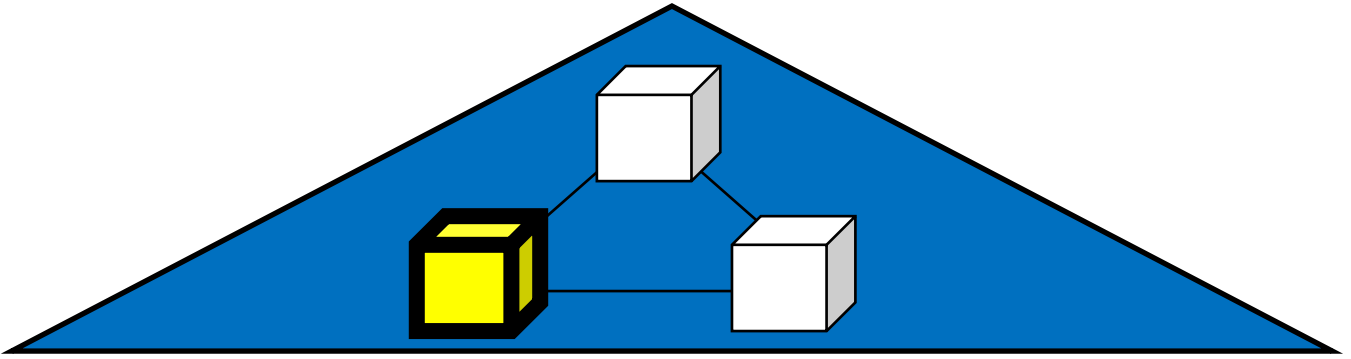

Semantics

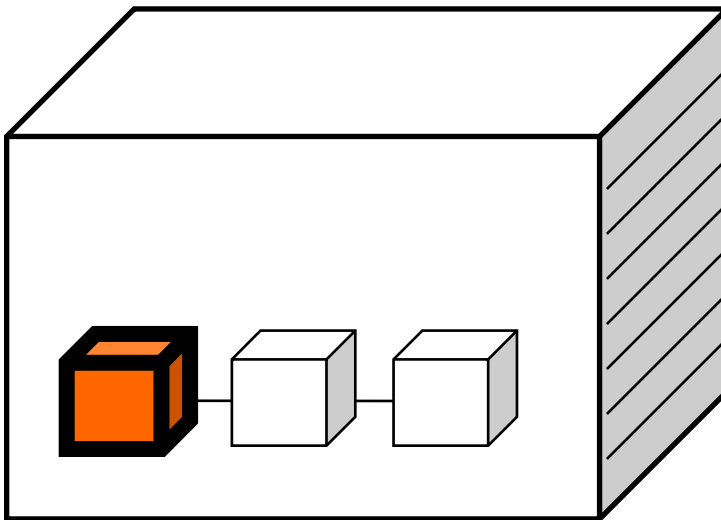

# Towards Explicite Semantics 2

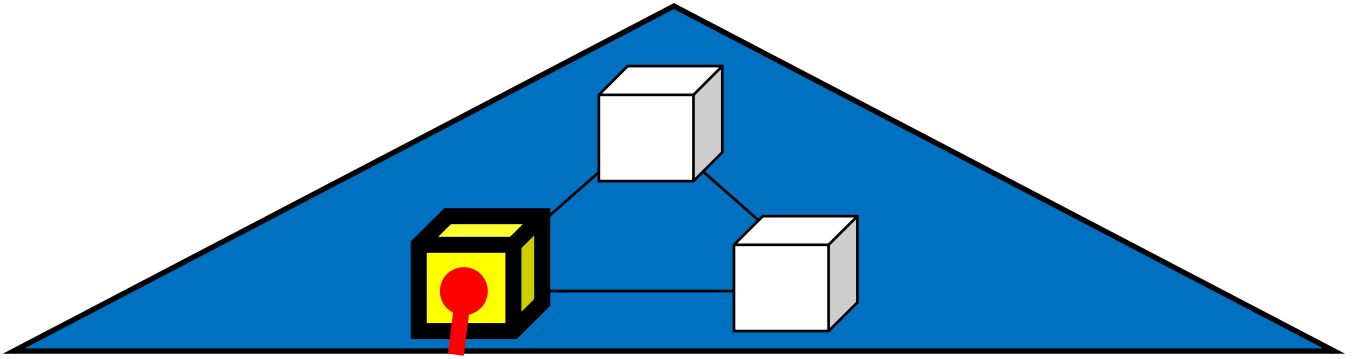

Semantics

Implicite Semantics

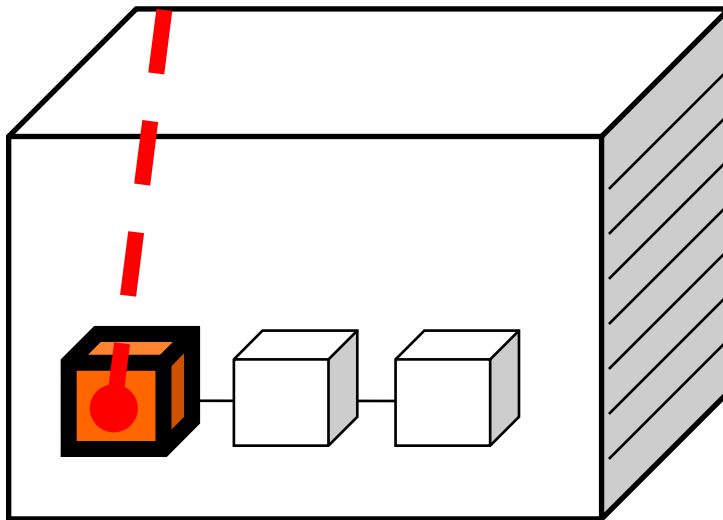

# Towards Explicite Semantics 3

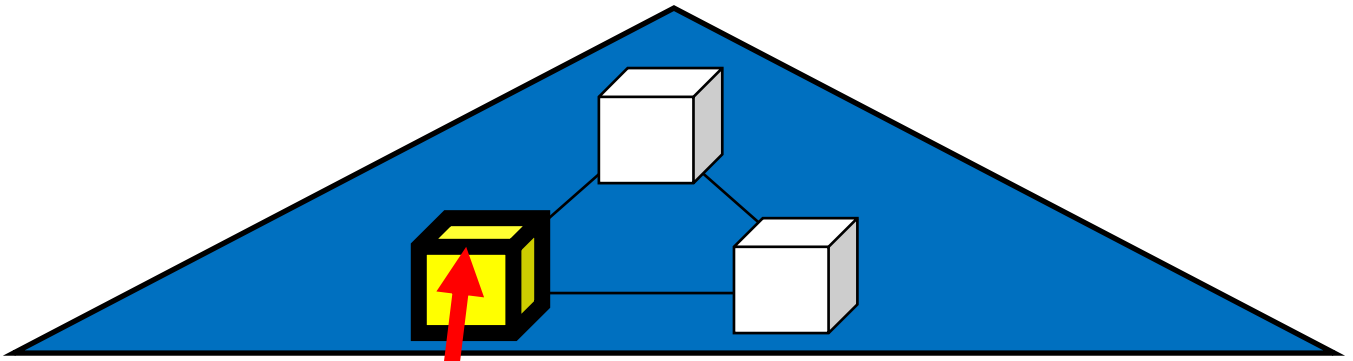

Semantics

**Explicite Semantics**

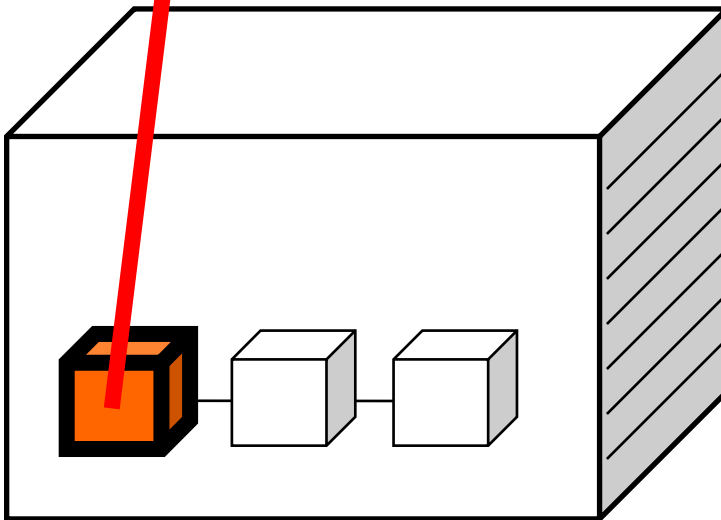

# Towards Explicite Semantics 4

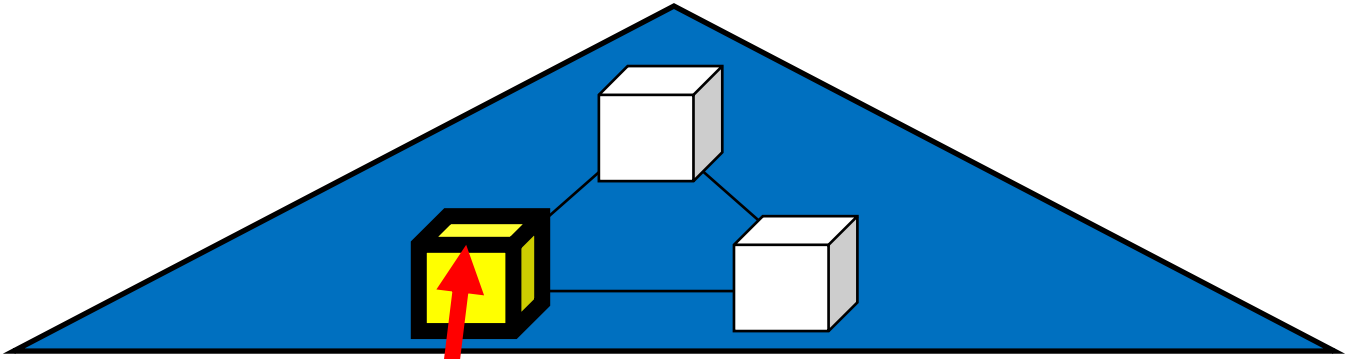

**Explicite Semantics**

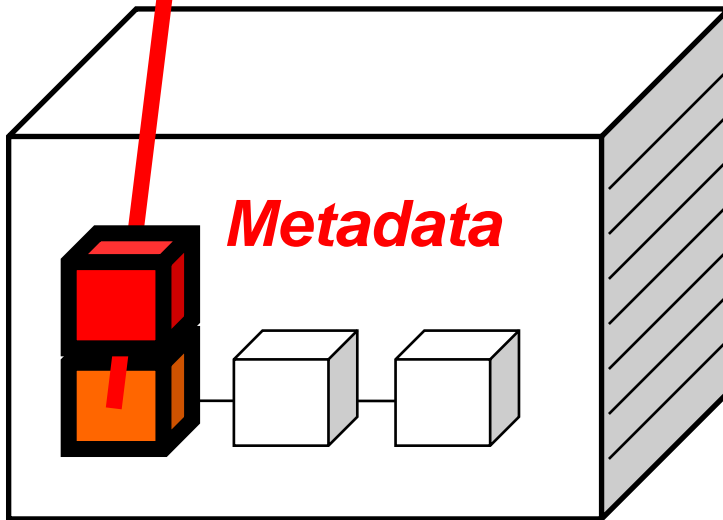

# Towards Explicite Semantics 5

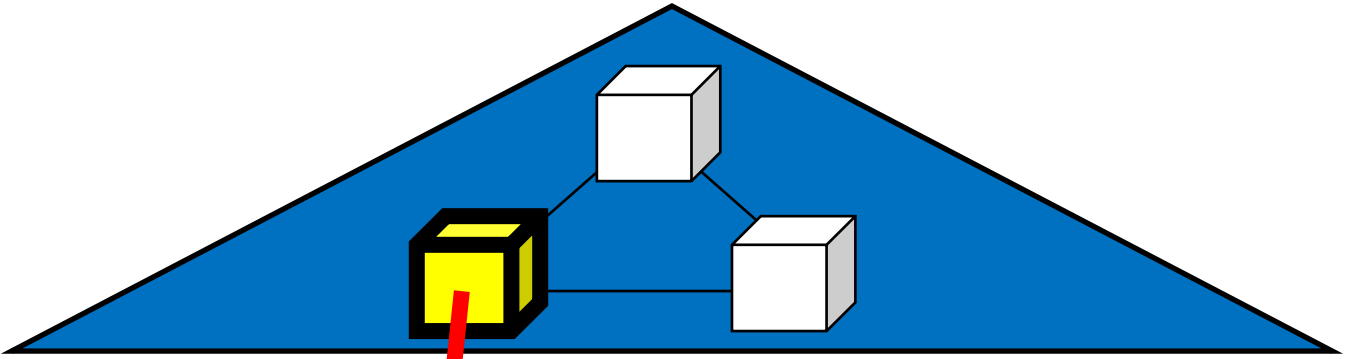

**Strong Semantics:**  
*(Platonism, Ontologies)*

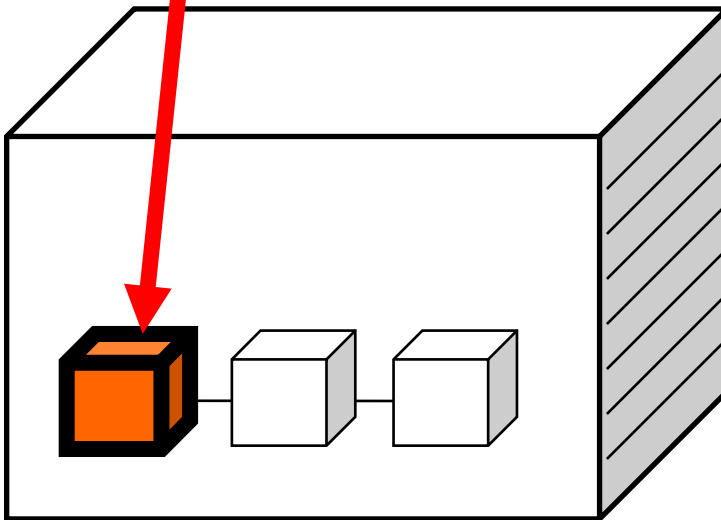

*harald.hoffmann@metadat.com*  
*friedrich.lachmayer@uibk.ac.at*